DUAL DIGITAL

pH / ORP / mV

CONTROLLER

DPH-4

USERS GUIDE

TABLE OF CONTENTS

SPECIFICATIONS	3
INTRODUCTION	5
<i>Normal dosing (nor)</i>	6
<i>Normal Proportional dosing (no.P)</i>	6
<i>Adaptive proportional dosing. (Ad.P)</i>	6
INSTALLATION	9
<i>Instrument</i>	9
<i>Wiring of the DPH-4</i>	10
<i>Signal output</i>	11
<i>Electrodes</i>	11
<i>Starting up the Instrument.</i>	11
CONFIGURATION	12
<i>Looking at menus and values</i>	12
<i>Default values for the DPH-4 instrument</i>	13
<i>Saving Values in Configuration.</i>	14
OPERATION	19
<i>Initial check of the DPH-4.</i>	19
<i>Calibrating the DPH-4 with a simulator.</i>	19
<i>Selecting Mode of Operation.</i>	21
<i>Using Timers.</i>	27
WARRANTY	28

SPECIFICATIONS

Range:	0 - 14pH, 0.01 pH resolution 0 - 1999mV with 1mV resolution.
Display:	Two 3 1/2 digit LCD displays.
Indicators:	LED lights indicate set point operation, pulse, flow, configuration and calibration status.
Calibration:	All calibration parameters are programmed into non-volatile memory.
Electrode:	BNC, external of housing.
Temperature:	Manual compensation selected in the configuration menu if in pH mode. Temperature range from 0 to 100°C. Automatic compensation possible with a TP150 electrode connected.
Signal output:	4-20mA software configuration over range 0-14pH or 0-1000mV. Current output fully isolated. Maximum termination impedance for 20mA is 1000 Ohms.
Control range:	Set point range 0pH to 14pH or 0 to +1000mV
Pulsed output:	Selected through setup program. Pulse width adjusts automatically to suit dosing requirements. On time varies from continuous to minimum 1 second. Pulse interval increases / decreases to further fine-tune a dosing cycle.

Output relays: 240 VAC, 5 Amps max. Resistive load. 3 terminals provide earth, neutral and switched active. 5A fuse protects instrument and relay output.

Alarm relays: Potential free contacts.

Power: 240VAC 50Hz 15VA max. Hardwired with screw terminals located under sub panel.

Housing: Fully sealed construction with hinged clear acrylic front cover. IP55 specifications.

Dimensions: 230mm x 190mm x 120mm.

INTRODUCTION

The DPH-4 instrument contains two separate pH/ORP controllers facilitating an efficient installation. The two instruments are electrically isolated to ensure reliable performance under all conditions. Each controller can be independently configured for pH or ORP and up or down SET POINT control. The operating modes of both instruments are programmed with rotary encoders incorporating a push button to accept dialled values. A second encoder allows the operator to configure the controller for various timing modes to prevent abnormal levels of chemical dosing or overshooting of the set points.

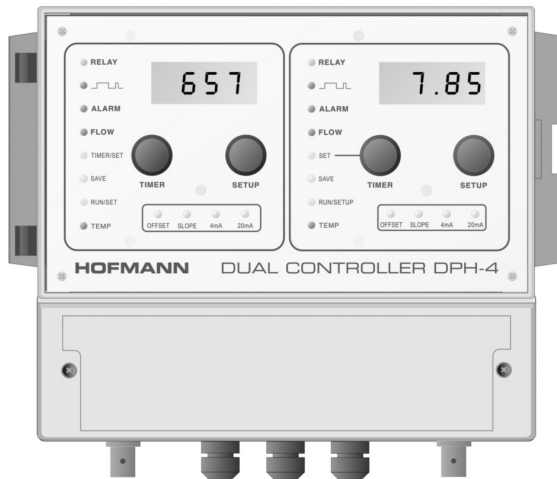

FIG 1 *DPH-4 CONTROLLER*

LED's show the operational status of the instrument or setup program currently available. Pushing the encoder prepares for performing configurations or calibrations. Rotating the encoder clockwise and pushing again enters the configuration menu to set up the instrument. Rotating the encoder anticlockwise and pushing enters the calibration menu. You scroll through menus with the encoder knob and once a menu is selected values are increased or decreased by rotating the encoder knob clock- or

anti-clockwise. The desired value is selected and saved with pushing the encoder until the “SAVE” LED flashes two times. *(See configuration)*

The large LCD display shows either signal input, configuration or calibration values such as set point or high/low alarm as selected by an operator.



The rotary encoder only becomes active if invoked through the instrument configuration program. This feature avoids setpoint or calibration values being changed inadvertently.

Three modes of set point control are possible:

Normal dosing (nor)

This is the normal dosing mode with simple on/off operation of the output relay. Up or down dosing is possible with normal dosing.

Normal Proportional dosing (no.P)

The relay output starts to pulse with a shortening of the ON cycle and a lengthening of the OFF cycle as the pH / mV moves toward the setpoint. The behaviour of the pulse mode can be modified by setting a “gradient” from 10 to 100. *(See Fig. 6)* Minimum pulse ON time when reaching the set point is 2 seconds. This can be changed from 1 to 9 seconds to suit all applications. These configurations only becomes available if no.P is selected. Up or down dosing is possible with normal proportional dosing.

Adaptive proportional dosing. (Ad.P)

The relay output of the DPH-4 instrument is controlled through a complex algorithm that continuously monitors the difference between actual pH / mV and set point. The output starts to pulse and varies the ON/OFF cycle as the input value approaches the set point value. The ON/OFF cycle however is also adjusted from a ‘correction factor’, which in turn is governed by the history of a previous dosing cycle. This makes for a fully dynamic dosing control, which adapts for widely varying dosing conditions. *(See Fig. 7)*

Dosing for an excessive period of time without a corresponding increase in pH is recognized as a possible failure. The output begins to pulse,

preventing overdosing. The pulse output exhibits a very wide duty cycle. The ON and OFF times are both dynamic, both varying from 1 to 60 seconds. Up or down dosing is possible with “Adaptive proportional Dosing”.

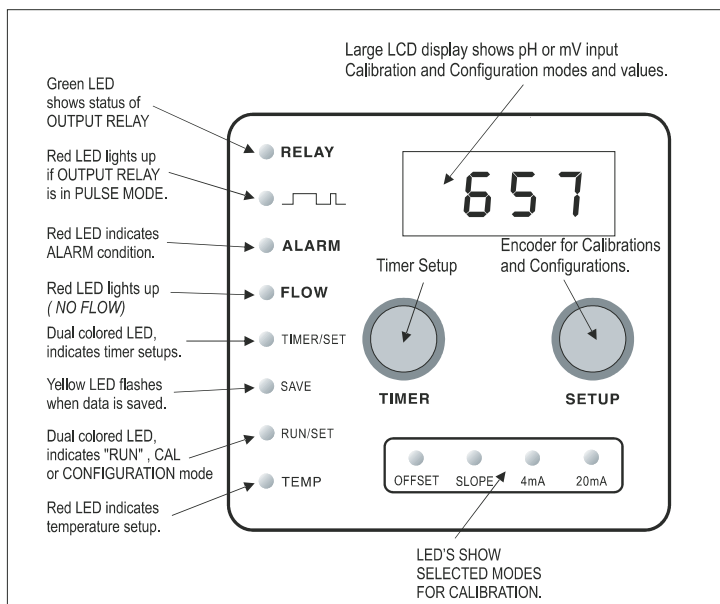

FIG 2 LED's show different conditions.



The DPH-4 program prevents gross overdosing in the event of a process upset or electrode failure. (Adaptive mode only)

Temperature compensation (*pH mode only*) is set for 20°C by default. This can be changed in the configuration program from 0 to 100°C. A TP150 temperature electrode connected to the terminals enables the option for automatic compensation.

The DPH-4 features an alarm relay with potential free contacts. Low and high alarm points are set in the configuration menu.

The flow switch input is configured to operate as N/O or N/C. (*normally open or normally closed*) The output relay is locked out and the relay LED flashes if no flow is detected. The flow LED indicates this condition. The two inputs can be parallel if only using one flow switch.

The inherent accuracy and range configuration of the 4-20mA constant current output together with full electrical isolation make it possible to interface into a microprocessor, logic controller or data logger to further expand the combination of installations with the DPH-4.

Timers can also be used to further protect against accidental overdosing.

If activated, TIMER 1 is started every time the instrument calls for dosing with an adjustable on time from 1 minute to 2 hours. If the set time is exceeded without the set point relay deactivating, TIMER 2 takes over, locks out the relay for the configured off time and indicates this with a flashing red “TIMER/SET” LED. TIMER 2 is adjusted from 1 to 30 minutes.

If looped mode (**LOOP**) is selected and the instrument still calls for dosing after TIMER 2 has run out TIMER 1 will take over and repeat the operation. The alarm relay can be configured to activate during TIMER 2.

In terminal mode (**n.LP**) TIMER 1 is triggered when the instrument calls for dosing. If the dosing takes place within the set time the instrument will function as normal. If for some reason the condition for dosing remains and TIMER 1 runs out the dosing relay is disabled and indicates the state with a flashing LED. “**SEt**” is displayed when pushing the timer encoder to indicate a lockout condition. Push for 1 second to clear the lockout. Dosing is again resumed.

The alarm relay is always activated if the controller is in terminal lockout.

The flow input will always disable the dosing relay and activate the alarm relay even if the timers are disabled making this feature useful for no flow or low level alarms. This condition is indicated with the flow LED red and the relay LED flashing.

INSTALLATION

Instrument

Select a position for the controller to be mounted on a wall, not facing into direct sunlight and protected from the weather elements as much as possible. The DPH-4 should be installed near the treatment plant. Maximum length of the co-axial cable used should not exceed 10 metres because of the very high input impedance characteristic of a pH electrode.

The metal electrodes used for redox measurements are of much lower resistance and longer coaxial cables can be used without any special precautions.

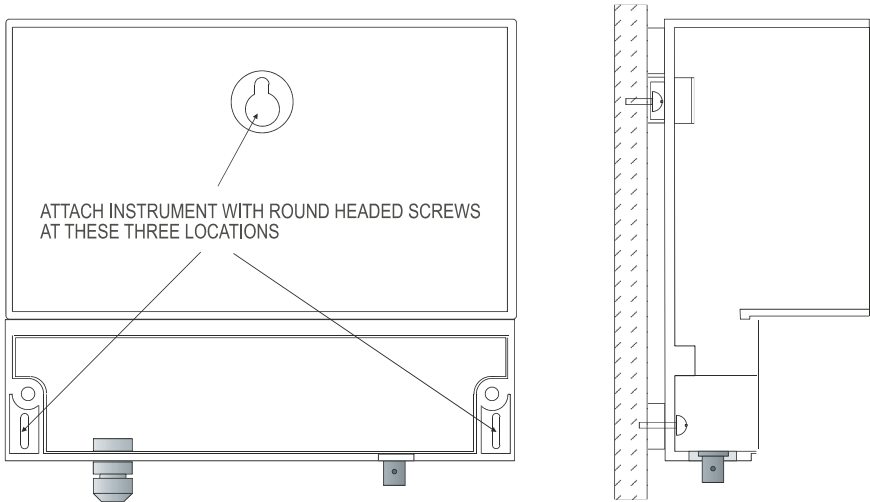

FIG 3 Attaching the DPH-4 to a wall

Insert a round headed screw into the panel where the instrument is to be attached. This screw determines the centre of the instrument location. (Fig.3) Slide the instrument over the slot opening at the back, check that the unit hangs level and secure it with two screws inserted through the slots at the two bottom corners.



Do not drill any holes into the enclosure to install the controller.

Wiring of the DPH-4

It is imperative that all connections are wired through the cable gland and the transparent lid is always tight to ensure that no corrosive liquids inadvertently splash into the instrument.

The 3 terminals for the SET POINT provide an earth, neutral and switched 240VAC (*active*) . A metering pump, solenoid valve or other device requiring 240V can be connected.

A suppression capacitor is already connected to filter electrical spikes caused by switching solenoid valves.

The alarm relay terminal has potential free contacts. (*N/O C N/C*)

You need to determine the N/O or N/C of a flow switch when connecting for proper configuration later on. Polarity does not matter when wiring a flow switch.



The Set point relay terminals connect to earth, neutral and switched active 240V. (240VAC is supplied to these terminals when activated by the set point.)

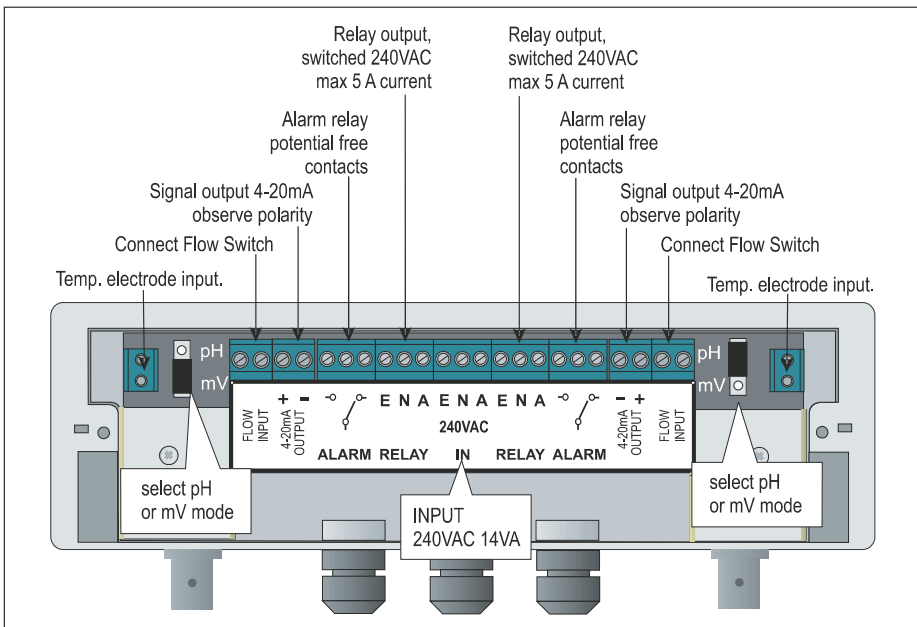

FIG 4 Terminal layout for the DPH-4

Signal output

The 4-20 mA signal current output can be used for event recording or to expand the control facilities for additional relay contacts. This output can be wired directly to a computer interface without causing earth loop problems. Correct polarity wiring is essential.

The current signal can also be configured to drive a metering pump with a signal input. (See Fig. 9)



Correct polarity has to be observed when connecting the 4-20mA signal output.

Electrodes

The co-axial cable used to connect the electrode to the DPH-4 must be of the type supplied with a carbon sleeve between the centre core and shield as any standard co-axial cable will cause a very erratic reading. An impedance converter must be used if the location between electrode and controller exceeds 10 meters. Special consideration also must be given when placing an electrode in a treatment bath or pool. The point of injection of neutralising agent and placement of the electrode (*distance between them*) largely determines the dosing characteristics of the DPH-4.



Only use special co-axial cable to connect a pH electrode to the DPH-4.

Starting up the Instrument.

After you have installed the instrument and checked all the wiring and connections open the isolation valves to the sensor to allow water flow across it. Plug the power cord into the supply and switch on the DPH-4. The "RUN/CONFIG" LED will light up green and the digital display shows the measured input value.



To quickly change the setpoint push and hold down the encoder until the green LED flashes and the present setpoint is displayed. Release and dial a new setpoint. Push again until the SAVE LED flashes two times.

CONFIGURATION

Looking at menus and values without changing or saving.

The DPH-4 is now in 'RUN' mode and processes the mV signal, output and alarm relays and the signal output. This condition is indicated with the green 'RUN/CONFIG' light. Turning the encoder knob has no effect.

Now push the encoder knob. The LED changes to flashing red. Turn the knob clockwise. The LED changes to steady red and the display shows **CnF**. Now push to move to the first configuration mode. The display shows UP. Slowly rotate the knob to sweep through all the modes:

Dosing up / down,

Setpoint,

Dosing mode

Low and high alarm Flow switch

4-20mA Signal

End

The corresponding LED lights up for each of the above position to show which mode is indicated with the LCD display.

The next step shows **End**, here you can exit back to 'RUN' by pushing the encoder or continue to step clock-wise or anti-clockwise to look at the configurations again. There is no need to exit manually as the DPH-4 automatically returns to 'RUN' after 2 minutes if left anywhere in the configuration or calibration menu.



The DPH-4 automatically returns to 'RUN' after 2 minutes if left anywhere in the configuration or calibration menu.

If a program mode is entered inadvertently by pushing the encoder simply push again until the 'SAVE' LED flashes. The same mode or value is retained as was previously programmed.

Default values for the DPH-4 instrument

The DPH-4 is shipped with default values programmed in non-volatile memory.

mV MODE

Dosing = UP	UP
Setpoint = 500	500
Dosing Mode = normal dosing	no.d
Low Alarm mV = 200	200
High Alarm mV = 800	800
Flow Switch = Normally open	OP
4-20mA signal output mode = normal	nor
4mA = 000mV	000
20mA = 1000mV	1000

pH MODE

Dosing = UP	UP
Setpoint = 7.00	7.00
Dosing Mode = normal dosing	no.d
Temperature Compensation	
Manual (+20.0°C)	S.oC (+20.0)
Low Alarm pH = 2.00	2.00
High Alarm pH = 12.00	12.00
Flow Switch = Normally open	OP
4-20mA signal output mode = normal	nor
4mA = 0.00pH	0.00
20mA = 14.00pH	14.00

Of course all values can be customised through the configuration setup. Entered values are stored in non-volatile memory and are not lost through power failure.

Changing and Saving Values in Configuration.

This chapter only explains the different selections available and how to change modes or values. Look up “OPERATION” for more details of when to use different settings.

General:

Table 1 (pH) and Table 2 (mV) is an overall diagram of all the variables that can be changed in configuration. The LCD display shows a mode or value and the appropriate LED lights up to show the position presently showing. Pushing the encoder prepares to change this value. This is indicated by the LED flashing. To save a change push until the yellow “SAVE” LED flashes twice. The change is now saved in non-volatile memory and will be used by the DPH-4.

This manual from now on will say:

Pushing the encoder: ‘**PUSH**’

Pushing the encoder until the save LED flashes twice: ‘**SAVE**’

Clockwise direction of the encoder knob: Rotate ‘**CW**’

Counter-clockwise direction of the encoder knob: Rotate ‘**CCW**’

Either direction of the encoder: “**Rotate**”



To change large numbers quickly rotate the encoder in a “flicking” manner.

Dosing mode is selected for up [**UP**] or down [**dn**].

Setpoint is selected between 0.00 to 14.00pH or 000 to 1000mV

Next select the relay output mode. There are three options.

Normal dosing [**no.d**], Normal Proportional dosing [**no.P**] and

Adaptive Proportional dosing [**Ad.P**]

(pH only) Temperature compensation is selected manually in +oC mode. ‘PUSH’ and dial up the new temperature. Range is 0 to 100°C.

Connecting a TP150 temperature electrode enables the DPH-4 to use automatic compensation. Select **SoC** for manual or **AoC** for auto compensation. In **AoC** mode the actual temperature is displayed.

Exit without saving by rotating the encoder (*Temp LED goes off*) and then ‘PUSH’. Press ‘SAVE to accept automatic compensation.



Automatic temp. compensation is not available if no temp. electrode is connected.

The next menu sets low and high alarm. The alarm LED flashes slowly when dialling low alarm, fast when dialling high alarm. Low alarm range is from 0.00pH (000mV) to high alarm. High alarm range is from low alarm to 14.00pH. (1000mV)



A flashing LED indicates that a value can be modified in this position.

Flow switch configuration mode is selected for normally open [**OP**] or normally closed. [**CL**]

4-20mA output is configured for normal [**nor**] or setpoint [**SP.**] operation. The pH / mV for 4mA and 20mA are selected in the next configuration. First the 4mA LED flashes to allow entering and 'SAVE' pH / mV for 4mA. Repeat this procedure for 20mA. 4mA range is from 0.00pH (000mV) to pH7.00 (500mV). 20mA range is from pH8.00 (600mV) to pH14.00 (1000 mV).

Only the 20mA slope is entered in mA Setpoint. Range for the mA slope is 0.5 to 5.00pH (50 to 500 mV). 4mA always is setpoint. It is important to note that dosing mode [**UP, dn**] is properly selected if SP. mode is used.

If additional changes are necessary rotate 'CW' or 'CCW' to return to any of the above mentioned options. Only a single configuration change can be made if necessary. There is no need to configure from beginning to end.



A single configuration change can be made if necessary. There is no need to configure from beginning to end.

When all configurations are done step to the next menu [**End**] to exit. 'PUSH' returns to operating mode. The DPH-4 always returns to operating mode after 2 minutes if left in configuration or calibration mode.



The DPH-4 automatically returns to 'RUN' after 2 minutes if left anywhere in the configuration or calibration menu.

To only change the setpoint push and hold down the encoder until the green LED flashes and the present setpoint is displayed. Release and dial a new setpoint. Push again until the SAVE LED flashes two times.

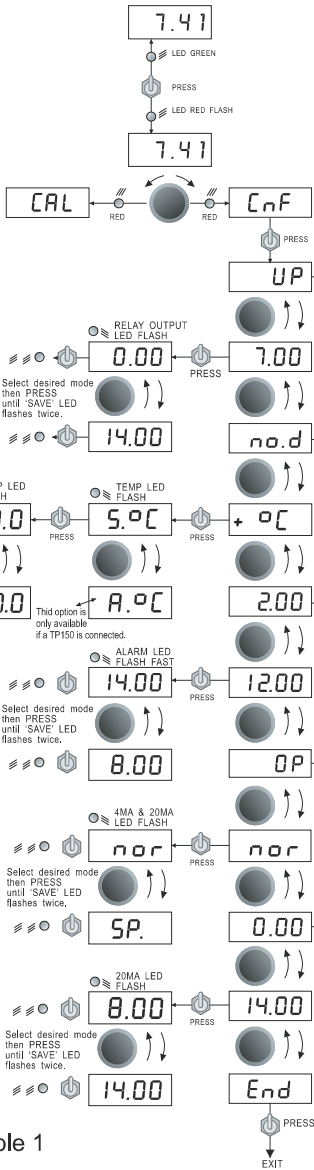

Rotate encoder knob clock- (CW) or counter-clockwise (CCW) to select different menus or change values.

Press momentary switch to enter setup mode or hold for 1 second to 'SAVE' selected mode or value.

Table 1
CONFIGURATION DIAGRAM

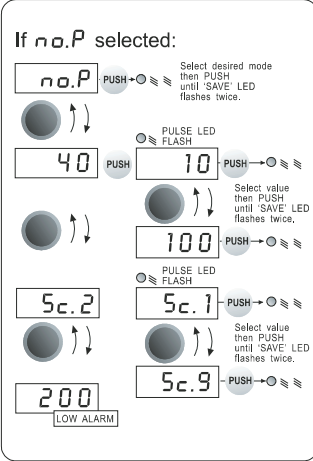

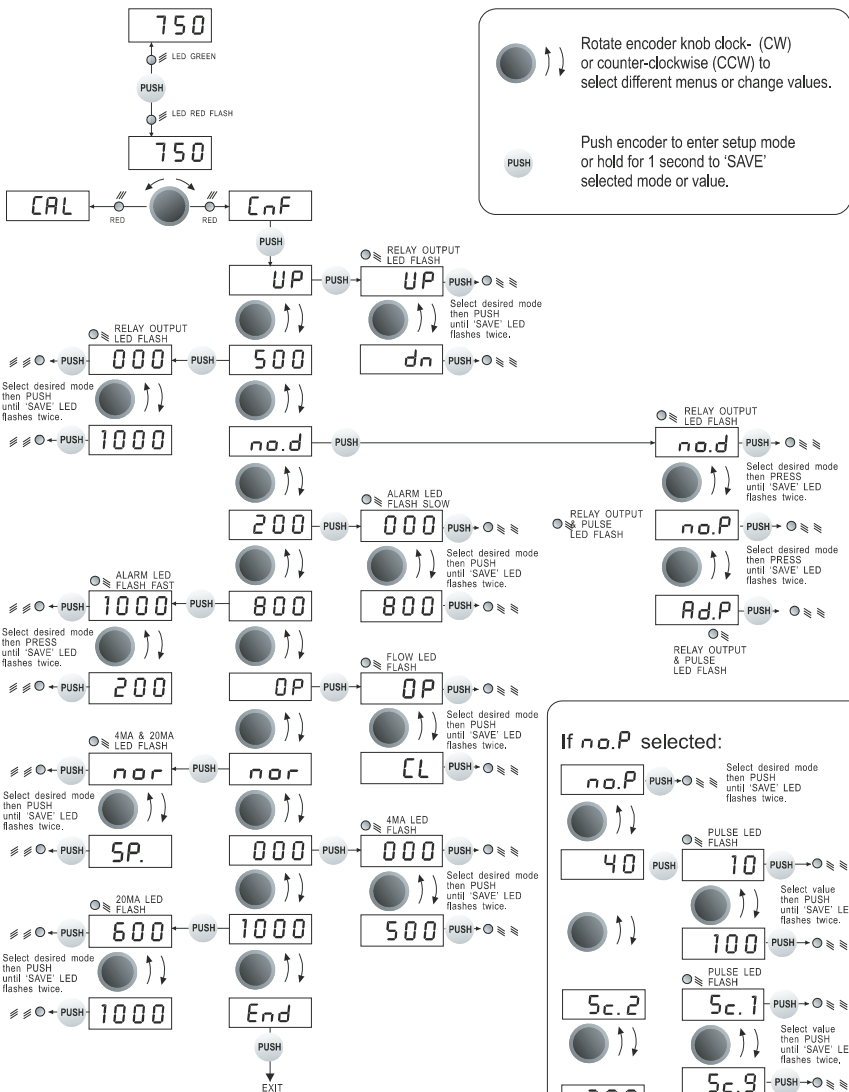
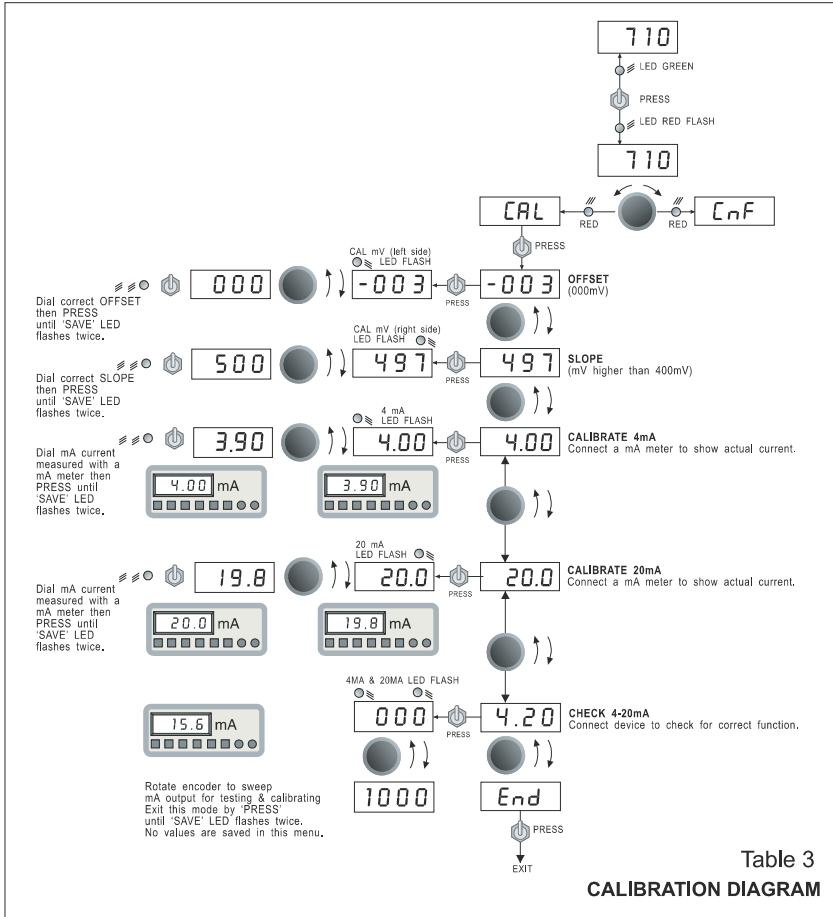

Table 2
CONFIGURATION DIAGRAM

Offset calibrations can be performed if the electrode signal is between pH 6.00 and 8.00 or -50 and +250mVA mV. The message 'Err' indicates if pH / mV is out of range. If this is the case 'PUSH' twice, adjust pH / mV for correct value and repeat offset calibration.



A slope calibration can be performed if the pH is lower than 5.5. or higher than 8.5 or in mV mode between 280mV and 900mV. The message 'Err' will show if this condition is not met. If this is the case PUSH twice, adjust pH / mV for correct value and repeat mV calibration.

OPERATION

Initial check of the DPH-4.

After the instrument is properly installed, an electrode or simulator connected and the power applied, the “RUN” LED will light up. The output relay may latch depending on the signal input. Sweeping across the range with a simulator will activate the relay and “RELAY OUTPUT” LED at the programmed setpoint.

Calibrating the DPH-4 with a simulator.

The operator should be familiar with the different effects if OFFSET and SLOPE calibrations are carried out. Offset adjustments increase or decrease the reading regardless of the absolute measured value. pH7 is a prefixed iso-potential and increasing the slope always moves the reading away from pH7. Readings below pH7 therefore decrease in the displayed value. Readings above pH7 increase in the displayed value. (Fig.6)

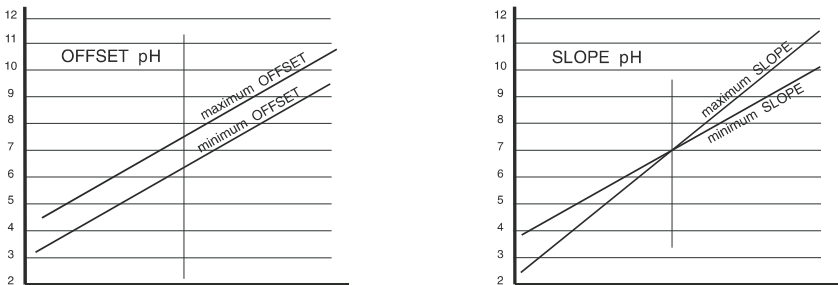

FIG. 5 THE DIFFERENT EFFECTS OF OFFSET AND SLOPE.

OFFSET calibrations should be carried out first, however offset and slope calibrations can be performed separately and need not be done consecutively.

Set the simulator to pH 7.00

‘PUSH’ and ‘Rotate CCW’ to go to CAL. ‘PUSH’ turns on the offset LED. ‘PUSH’ again, the offset LED now flashes and the display shows “live” pH

input. 'Rotate' until 7.00 shows on the display and 'SAVE'. Offset is now calibrated.

An offset calibration can only be performed if the pH is between 6.00 and 8.00. The display shows **Err** if a value outside these parameters is present. 'PUSH' two times, the display shows "live" pH to allow the operator to correct for a valid offset pH value. 'PUSH' now returns to the offset calibration menu to repeat the procedure.

Rotate 'CCW' goes to End then 'PUSH' to exit. Rotate 'CW' proceeds to the slope calibration.

SLOPE calibration.

Set the simulator lower than pH 5.50 or higher than pH 8.50

'PUSH' turns on the slope LED. 'PUSH' again, the slope LED now flashes and the display shows "live" pH input. 'Rotate' until the correct slope value shows on the display and 'SAVE'. Slope is now calibrated.

An accurate slope calibration can only be performed if the pH is lower than 5.50 or higher than 8.50 The display shows Err if a value inside these parameters is present. 'PUSH' two times, the display then shows "live" pH to allow the operator to correct for a valid pH value. 'PUSH' now returns to the slope calibration menu to repeat the procedure.

Rotate 'CCW' two times goes to **End** then 'PUSH' to exit. Rotate 'CW' proceeds to mA calibrations. (*See 4-20mA output*)

Redox electrodes

Contrary to pH electrodes, redox (*metal electrodes*) do not exhibit changes in slope or zero point. Nevertheless one may occasionally experience wrong redox measurements, most frequently the cause being a contaminated electrode. Cleaning and/or regeneration of the electrode will cure the problem. It is very unusual to get wrong readings with redox electrodes when using redox buffer solutions. The use of redox buffers therefore is restricted to a simple function test of a redox electrode.

The mV offset and mV slope calibration modes of the DPH-4 are mainly used to correct minor instrument offset or gain errors of the input section.

mV offset calibrations should be carried out first, however mV offset and mV gain calibrations can be performed separately and need not be done consecutively.

Set the simulator to read 000mV (*no signal output*).

'PUSH' and 'Rotate CCW' to go to CAL. 'PUSH' turns on the OFFSET (*left side*) LED. 'PUSH' again, the LED now flashes and the display shows "live" mV input. 'Rotate' until 000 shows on the display and 'SAVE'. mV offset is now calibrated.

Rotate 'CCW' goes to End then 'PUSH' to exit. Rotate 'CW' proceeds to the mV CAL (gain) calibration.

A mV gain calibration can only be performed with more than 280mV input. The display shows **Err** if a value outside these parameters is present. If this happens 'PUSH' two times, the display shows "live" mV to allow the operator to correct for a valid mV offset value. 'PRESS' now returns to the calibration menu to repeat the procedure.



Set the simulator mV output higher than 280mV.

'PUSH' turns on the SLOPE (*right side*) LED. 'PUSH' again, the LED now flashes and the display shows "live" mV input. 'Rotate' until the correct mV value shows on the display and 'SAVE'. The mV reading of the DPH-4 is now accurate.

Rotate 'CCW' two times goes to End then 'PUSH' to exit. Rotate 'CW' proceeds to mA calibrations. (*See 4-20mA output*)

Selecting Mode of Operation.

Dosing

Adding chemicals such as chlorine or bromine to water increases the reading. The DPH-4 has to stop the pump or valve at the entered setpoint. The reading of the water to be treated therefore is below the desired value, (*selected SET POINT*) therefore dosing is set to UP.

In a situation where the reading of the water is reduced, the water to be treated is above the desired value, (*selected SET POINT*) therefore dosing is set to down.

Setpoint

Once the input signal reaches setpoint the output relay switches off. A dead band of 0.15pH (15mV) is used in normal mode. The relay output switches on again at 0.15pH (15mV) above/below setpoint. (*depending on UP/dn mode*)

Dosing mode

In normal dosing mode [**no.d**] the output relay simply switches on and off below or above the setpoint. (*depending on UP/dn mode*)

In normal Proportional mode [**no.P**] the relay output starts to pulse on and off once the input mV moves toward the setpoint. The difference of input signal versus setpoint is controlled by the amount of “gradient” set in the configuration program.

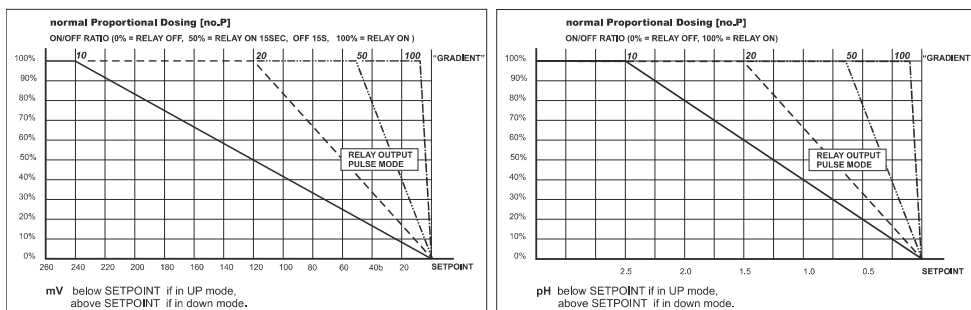

FIG. 6 Normal Proportional Dosing.

The lowest setting of 10 starts the output relay pulsing if 3.00pH (240 mV) below/above setpoint. The on/off ratio gradually reduces until the relay switches off at setpoint.

Setting the gradient to the maximum of 100 starts the output relay pulsing when 0.5pH (10 mV) below/above setpoint giving a very steep gradient. The on/off ratio reduces very rapidly. (See Fig.6) for ‘gradient’ versus pulse output.

Depending on the application and pumps or valves used a shorter or longer minimum pulse is desirable. The minimum pulse length is selected in the next window (**Sc.2**) Pulse width is from 1 to 9 seconds.

In Adaptive Proportional mode [**Ad.P**] the relay output is controlled through a complex algorithm that continuously monitors the difference between actual mV and set point. The output starts to pulse and varies the ON/OFF cycle as the mV-input approaches the set point value. The ON/OFF cycle however is also adjusted from a 'correction factor', which in turn is governed by the history of a previous dosing cycle. This makes

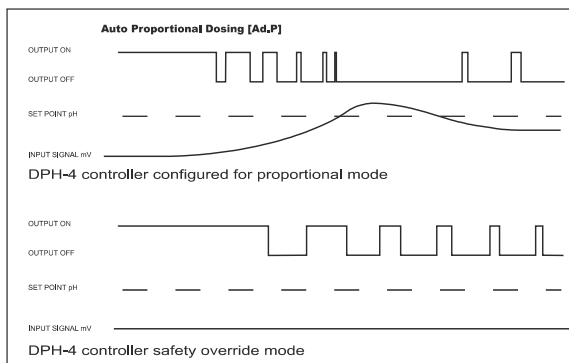

FIG. 7 Adaptive Proportional Dosing.

for a fully dynamic dosing control, which adapts for widely varying conditions in a cooling tower or other plant installations. Dosing for an excessive period of time without a corresponding movement in mV is recognized as a possible failure.

The output begins to pulse, preventing overdosing.

The pulse output exhibits a very wide duty cycle. The ON and OFF times are both dynamic, varying from 1.5 to 30 seconds.

Up or down mode is possible with Adaptive Proportional dosing.

The time taken for the DPH-4 to register the neutralising effect of the chemicals injected depends on the mixing and retention time of the plant installation. The distance between the injection point of neutralising agent and the electrode greatly affects the quantity released into the system.

Therefore which dosing mode to use largely depends on an installation and can possibly only be determined on site after some initial running of the plant.

Alarm

A second relay with potential free contacts controlled through configured low and high alarm mV points can be connected to an alarm device or use the potential free relay contacts for event monitoring or recording digital data into a central processor system. The relay can be used as a second setpoint control output.

Flow-switch

A flow-switch connected to the DPH-4 prevents dosing chemicals if for any reason the water flow has stopped. Two types of flow-switches exist: The term “normally open” is used if the contacts are open with flow and close if flow stops. Select **OP** mode if this type of switch is used.

The term “normally closed” is used if the contacts are closed with flow and open if flow stops. Select **CL** mode for this type of switch.

If it is not certain what type of switch is in the system operate the DPH-4 and configure for **OP** or **CL** until normal operation of the relay output is established with water flowing. If no water flows through the system the DPH-4 prevents the relay from switching and flashes the green LED.

4-20mA signal output.

The DPH-4 features two modes of operation for the 4-20mA signal output. In normal operation [**nor**] a “window” is configured by selecting a low mV for 4mA and a high mV for 20mA current. The 4mA point is selected between 000 and 500 mV. The 20mA point is selected between 600 and 1000 mV.

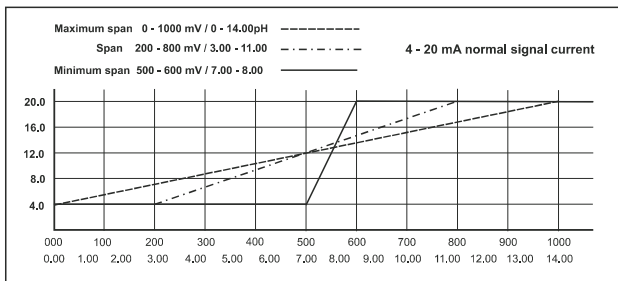

FIG. 8 4-20mA normal Signal current control.

This shows that mV can be traced over the entire 1000mV range or as little as 100 mV. (See Fig.8)

Choosing setpoint control **[SP.]** fixes the 4mA to the programmed setpoint. The signal current increases as the actual mV moves away from the setpoint. In UP mode the signal current increases as the mV falls below the setpoint. In dn mode the signal current increases as the mV rises above the setpoint. (See Fig.9)

The amount of current increase versus mV is governed by the programmed slope that can be selected from 50 to 500mV. (Do not confuse the term “slope here with the slope calibration of mV).

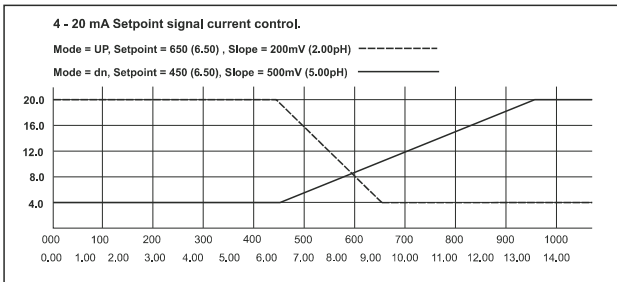

FIG. 9 4-20mA Setpoint Signal current control.

Example:

Mode is UP, setpoint is 650 m and mA slope is set at 200 mV.

Signal current output is 20mA as long as the mV is below 450 mV, starts to decrease as the mV moves to 950 at which point signal current is 4mA.

Calibrating 4mA and 20mA with a multimeter.

A real current calibration is carried out by connecting a multi meter across the terminals (*no termination resistor is required*) to measure the mA current.

The meter can also be connected in series in an already existing installation. (See Fig.10)

Enter calibration **[CAL]** and 'Rotate' until the 4mA LED lights up. 'PUSH' to enter 4mA calibration. The display shows 4.00. Dial the measured mA with 'Rotate'. 'SAVE' and the actual current is corrected to 4.00mA. Move

to 20mA and proceed the same way. If a calibration is not exactly accurate the first time simply repeat the procedure until the current output reads correct.

Using the DPH-4 as a 4-20mA Simulator

Entering **4.20** mode enables the operator to sweep the 4 to 20mA signal current for testing, setting up or calibrating an installation for accurate and correct performance between signal output and connected appliance or computer interface.

4.20 mode is only a utility program to assist for testing and no modes or values are changed or saved when using or exiting this mode.

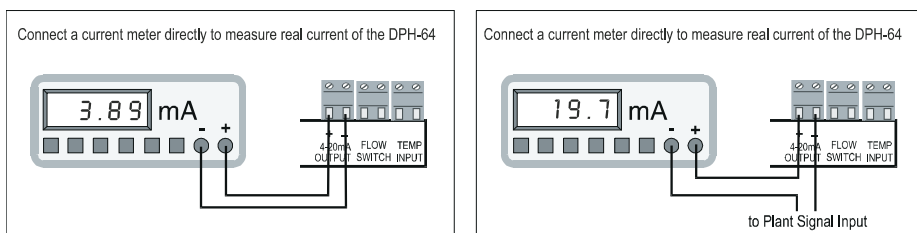

FIG 10 Calibrating 4-20mA with a multimeter.

The current output is controlled by rotating the encoder within the range as configured in the 4mA and 20mA setup.

The displayed [H / mV] generates exactly the same mA signal current as the pH / mV input in 'RUN' mode. When finished with the simulator mode exit with 'SAVE'.



No modes or values are changed or saved when using 4.20 mode.

Using Timers.

The DPH-4 provides 2 timing modes for selection, looped (**LOOP**) or terminal (**n.LP**). Each exhibits different operating characteristics. It is beyond the scope of this manual to outline all possibilities of added safety these modes can provide for an installation.

LOOPED This mode is applicable when a problem situation arises from chemical overdosing caused by slow chemical reaction time, sluggish or no mixing of chemical with the liquid.

TERMINAL This mode will safe guard an installation against severe overdosing of chemicals as a shut down of the treatment is invoked should the duration of a dosing cycle exceed the preset time of **TIMER 1**. This will reduce the problem of continuous over-dosing of chemical into the system, caused by faulty or damaged electrodes, co-axial cables etc. The DPH-4 continuous to monitor the liquid but does not operate the relay control output.

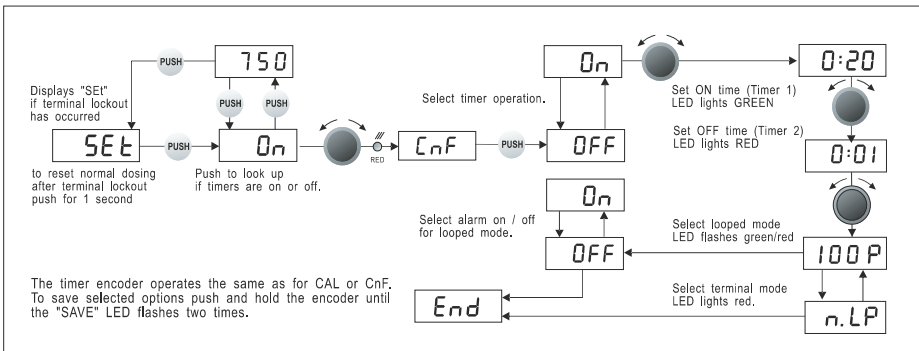

FIG 11 Configuration of Timers.

Terminal mode operation enables an operator to attend and rectify a problem of a pool before a severe overdosing of chemicals has occurred. After resetting the instrument, dosing will resume normally providing the problem causing the shut down has been rectified.

WARRANTY

We, **HOFMANN ELECTRONICS**, guarantee this unit against defects due to faulty manufacture or breakdown of components for a period of twelve month from the date of purchase, subject to the following provisions:

- The guarantee will cover original failure of parts and natural defects due to manufacturing causes. Otherwise repair charges are to be to the owners cost.
- The warranty does not cover any carriage costs.

The warranty is void if:

- The instrument is damaged due to rough handling or transport after purchase.
- The article has not been used in accordance with the operating instructions.
- Any parts in the instrument have been changed or have been altered in any way.
- The serial number is removed or defaced.

All other warranties and conditions, express or implied, are void.

◦ DPH-4

SERIAL No.

Due to a continuing effort to improve the product the manufacturer reserves the right to change or alter the product without notices.